

### Features

- Vitreous China.
- Comfort Height® Elongated Bowl.
- Revolution 360™ swirl flushing system powered by AquaPiston®.
- Includes left-hand polished chrome trip lever.
- 1.28 gpf (4.8 lpf).
- 2-1/8" (54 mm) fully glazed skirted trapway.
- Patented ReadyLock™ installation system.
- 12" (305 mm) rough-in.
- CleanCoat® surface coating.
- Less seat and supply.
- 9-3/4" (248 mm) x 7-1/4" (184 mm) water area.
- 29 1/2" (749 mm) x 16-1/2" (419 mm) x 31-3/8" (797 mm).
- Floor mount / Floor outlet.

### Recommended Accessories

- K-4008 Reveal® Quiet-Close™ Elongated Toilet Seat
- K-4108 C3®-230 Elongated Cleansing Toilet Seat
- K-7637 Angle Supply with Stop (single)
- K-5383 10" Rough-in Full Skirt Trap and Attachment System
- K-5381 14" Rough-in Full Skirt Trap and Attachment System
- K-20120-L Trip Lever

### Components

Product includes:

- K-4143 Toilet Tank
- K-4144 Elongated Toilet Bowl
- Additional included component/s: Tank Cover, Trip Lever, and ReadyLock™ installation system.



**ADA** **CSA B651** **OBC**

### Codes/Standards







ASME A112.19.2/CSA B45.1  
DOE - Energy Policy Act 1992  
EPA WaterSense®  
California Energy Commission (CEC)  
ADA  
ICC/ANSI A117.1  
CSA B651  
OBC

### KOHLER® One-Year Limited Warranty

See website for detailed warranty information.

### Available Color/Finishes

*Color tiles intended for reference only.*

Color	Code	Description
	0	White
	96	Biscuit
	NY	Dune
	95	Ice™ Grey
	G9	Sandbar
	7	Black Black™

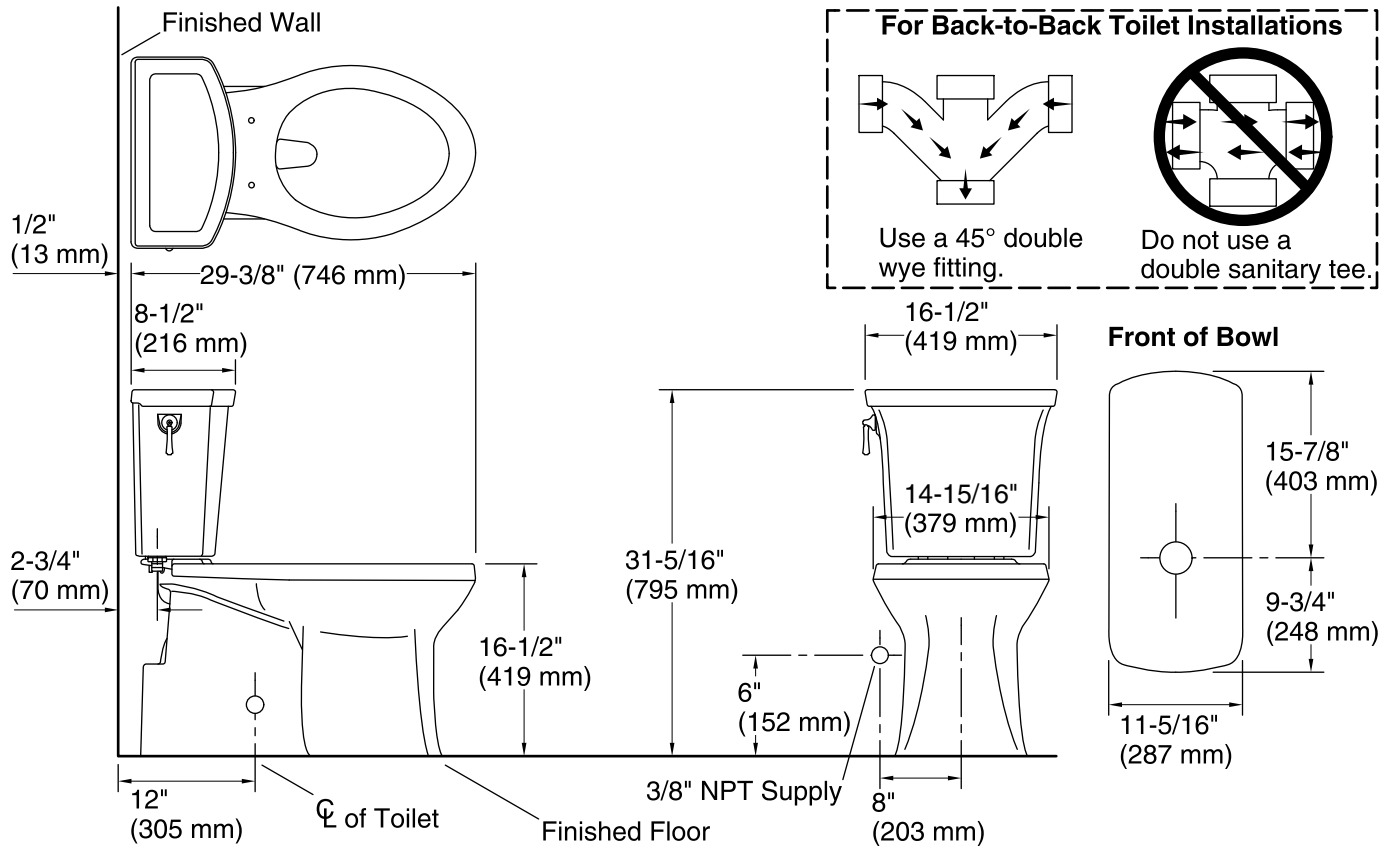

### Technical Information

All product dimensions are nominal.

Toilet type:	Two-piece, Floor-mount
Waste Outlet:	Floor
Bowl shape:	Elongated front
Flush type:	Gravity siphon jet
Trap passageway:	2-1/8" (54 mm)
Water Consumption	
Full:	1.28 gpf (4.8 lpf)
Water surface size:	9-3/4" x 7-1/4" (248 mm x 184 mm)
Rim to water surface:	6-1/4" (159 mm)

### Fixture Supply Requirements

Min static pressure:	15 psi (103.4 kPa)
Max static pressure:	80 psi (551.6 kPa)

### Notes

Install this product according to the installation instructions.

For back-to-back toilet installations: Use only a 45° double wye fitting.

ADA, OBC, CSA B651 compliant when installed to the specific requirements of these regulations.

Plumbing Codes require elongated toilets and elongated, open-front toilet seats in public bathrooms.

Accessibility standards require controls to be located on the open side of the toilet.



## OPTIONAL UPGRADE - Corbelle®

ContinuousClean XT toilet tank, 1.28 gpf

### Features

- 1.28 gpf (4.8 lpf)
- Left-hand Polished Chrome trip lever
- ContinuousClean system automatically dispenses cleaning solution with every flush
- Works with any white toilet bowl cleaner tablet. Tablets last up to one year in ContinuousClean XT system
- AquaPiston® canister optimizes the flow out of the tank, harnessing gravity and the natural powerful reducing cascade of water to increase the power and effectiveness of the flush
- Easy-to-flush canister design requires less force to actuate than a 3" (76 mm) flapper, and has 90% less exposed seal material which resists conditions that cause wear, tear, shrinkage and swelling
- Optional: uses two AAA batteries (included) to power the LED system indicator light. System indicator light will notify user when system is working properly and when to replace cleaning agent or batteries
- Adjustment dial lets you set how much cleaning solution is dispensed with every flush



### Codes/Standards

ASME A112.19.2/CSA B45.1  
EPA WaterSense®

### KOHLER® Toilets and Seats Limited Warranty

See website for detailed warranty information.





### Technical Information

All product dimensions are nominal.

Toilet type: Bowl-mount  
Flush type: AquaPiston

### Available Colors/Finishes

*Color tiles intended for reference only.*

Color	Code	Description
	0	White
	96	Biscuit
	NY	Dune
	95	Ice™ Grey
	7	Black Black™

1-800-4KOHLER (1-800-456-4537)

Kohler Co. reserves the right to make revisions without notice to product specifications.

For the most current Specification Sheet, go to [www.kohler.com](http://www.kohler.com).

9-17-2023 22:35 - US/CA/MX

THE BOLD LOOK  
OF **KOHLER**®